

GLP20+ white

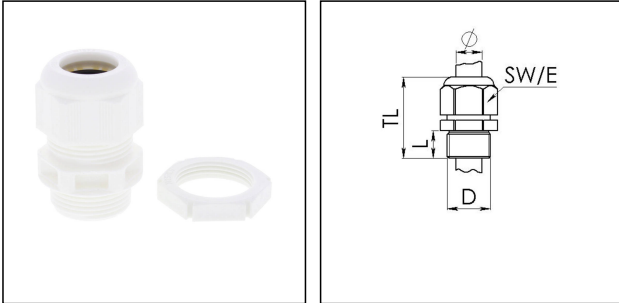

Products may differ in size, colour and appearance to those shown. If you require further information or customisation, please contact us directly.



Material cable gland	Polyamide
Material sealing gasket	EPDM
Protection class	IP68 (5 bar 30 min), IP69
Temp. range min	-40 °C
Temp. range max	100 °C
Glow wire test	750 °C
Thread type	M
Ø Connection thread D	20
Lead	1,5
Length screw-in thread L	10 mm
Ø cable diameter min	7,5 mm
Ø cable diameter max	14 mm
Key width SW	24 mm
Collar diameter (E)	27 mm
Total length TL	36 mm - 45 mm
Type of cable anchorage	A
Install. torques fitting	4 N/m
Install. torques fitting/EADR	3 N/m
Install. torques cap nut	3 N/m
Equipment	incl. locknut
Product Color	RAL 9001
Type	GLP20+ white
UK-Number	10100611
WISKA-Order no.	10100611
Packing unit	10

Your Contact:

WISKA UK Ltd.

Unit 7, Hurling Way · St. Columb Major Business Park · TR9 6SX, St. Columb Major, Cornwall · Great Britain

☎ +44-12-08816062 · 📠 +44-12-08816708

info@wiska.co.uk · www.wiska.co.uk



Tariff number	39269097
EAN number	4007685045346
ETIM-Classification	EC000441

13.05.2024

Your Contact:

WISKA UK Ltd.

Unit 7, Hurling Way · St. Columb Major Business Park · TR9 6SX, St. Columb Major, Cornwall · Great Britain

 +44-12-08816062 ·  +44-12-08816708

info@wiska.co.uk · www.wiska.co.uk



Your Contact:

WISKA UK Ltd.

Unit 7, Hurling Way · St. Columb Major Business Park · TR9 6SX, St. Columb Major, Cornwall · Great Britain

☎ +44-12-08816062 · 📠 +44-12-08816708

info@wiska.co.uk · www.wiska.co.uk