

GLP12 grey

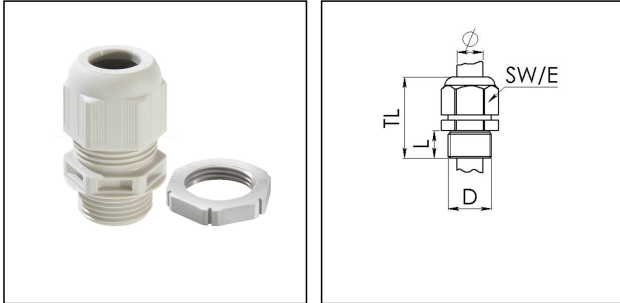

Products may differ in size, colour and appearance to those shown. If you require further information or customisation, please contact us directly.



Material cable gland	Polyamide
Material sealing gasket	EPDM
Protection class	IP68 (5 bar 30 min), IP69
Temp. range min	-40 °C
Temp. range max	100 °C
Glow wire test	750 °C
Thread type	M
Ø Connection thread D	12
Lead	1,5
Length screw-in thread L	9 mm
Ø cable diameter min	3 mm
Ø cable diameter max	7 mm
Key width SW	16 mm
Collar diameter (E)	18 mm
Total length TL	29 mm - 34 mm
Type of cable anchorage	A
Install. torques fitting	2 N/m
Install. torques fitting/EADR	2 N/m
Install. torques cap nut	2 N/m
Impact category	2
Equipment	incl. locknut
Product Color	RAL 7035
Type	GLP12 grey
UK-Number	99719
WISKA-Order no.	10106662

Your Contact:

WISKA UK Ltd.

Unit 7, Hurling Way · St. Columb Major Business Park · TR9 6SX, St. Columb Major, Cornwall · Great Britain

☎ +44-12-08816062 · 📠 +44-12-08816708

info@wiska.co.uk · www.wiska.co.uk



Packing unit	10
Tariff number	39269097
EAN number	4007686025415
ETIM-Classification	EC000441

20.05.2024

Your Contact:

WISKA UK Ltd.

Unit 7, Hurling Way · St. Columb Major Business Park · TR9 6SX, St. Columb Major, Cornwall · Great Britain

 +44-12-08816062 ·  +44-12-08816708

info@wiska.co.uk · www.wiska.co.uk



Your Contact:

WISKA UK Ltd.

Unit 7, Hurling Way · St. Columb Major Business Park · TR9 6SX, St. Columb Major, Cornwall · Great Britain

☎ +44-12-08816062 · 📠 +44-12-08816708

info@wiska.co.uk · www.wiska.co.uk